

FEATURES

- Plastic package has Underwriters Laboratory Flammability Classification 94V-0
- Metal silicon junction ,majority carrier conduction
- Guard ring for overvoltage protection
- Low power loss ,high efficiency
- High current capability ,low forward voltage drop
- High surge capability
- High temperature soldering guaranteed:260°C/10 seconds at terminals
- Component in accordance to RoHS 2015/863/EU



MECHANICAL DATA

- Case: JEDEC SMB(DO-214AA) molded plastic body
- Terminals: Solder Plated, solderable per MIL-STD-750,method 2026
- Polarity: Color band denotes cathode end
- Weight: 0.003ounce, 0.093 gram

SMB(DO-214AA)

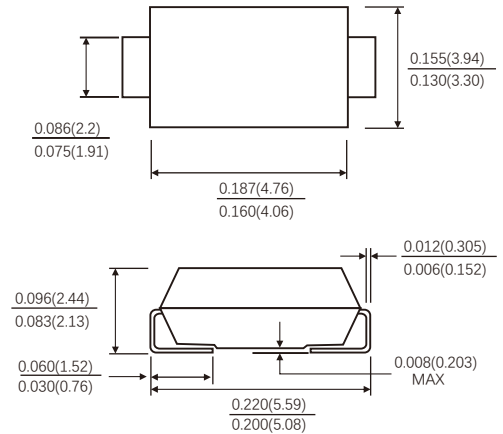

Suggested PAD Layout

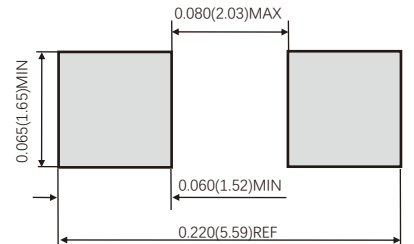

Dimensions in inches and (millimeters)

TYPICAL APPLICATIONS

For use in low voltage,high frequency inverter,DC/DC converters, free wheeling,and polarity protection applications

MAXIMUM RATINGS

(Ratings at 25°C ambient temperature unless otherwise)

Parameter	Symbol	Value	Unit
Maximum repetitive peak reverse voltage	V_{RRM}	40	V
Maximum average forward rectified current	$I_{F(AV)}$	8.0	A
Peak forward surge current 8.3ms single half sine-wave superimposed on rated load (JEDEC method at rated TL)	I_{FSM}	150	A
Operating junction temperature range	T_j	-55 to +150	°C
Storage temperature range	T_{stg}	-55 to +150	°C

ELECTRICAL CHARACTERISTICS (T_A=25°C Unless otherwise noted)

Parameter	Test Conditions		Symbol	Typ.	Max.	Unit
Instantaneous Forward Voltage	T _J =25°C	I _F =1A	V _F ¹⁾	0.38	-	V
		I _F =3A		0.43	-	
		I _F =8A		0.51	0.55	
	T _J =125°C	I _F =1A		0.31	-	
		I _F =3A		0.36	-	
		I _F =8A		0.47	-	
Reverse Current	T _J =25°C	V _R =40V	I _R ²⁾	-	100	μA
	T _J =125°C			-	50	mA
Typical Junction Capacitance	4V, 1MHz		C _J	420		pF

Notes: 1.Pulse test: 300 μs pulse width, 1% duty cycle

2.Pulse test: pulse width ≤ 40ms

THERMAL CHARACTERISTICS

Parameter	Symbol	SMB	Unit
Typical thermal resistance ³⁾	R _{θJA}	70.0	°C/W
	R _{θJL}	15.0	

3. Unit mounted on PC board with 5.0mm×5.0 mm (0.013 mm thick) copper pads as heat sink. (dPtot/dtj) < (1/R_{θJA}) is thermal runaway condition for a diode

AVAILABLE PACK INFORMATION

Product code	Pack	Reel Size (mm)	Quantity (pcs/reel)	Box Size L×W×H (mm)	Quantity (reel/box)	Carton Size L×W×H (mm)	Quantity (box/carton)	Quantity (K/carton)
SS84B-SMB	T/R	Φ330	3000	330×333×39	2	370×370×360	8	48

RATINGS AND CHARACTERISTICS OF SS84B

Fig.1-Forward Current Derating Curve

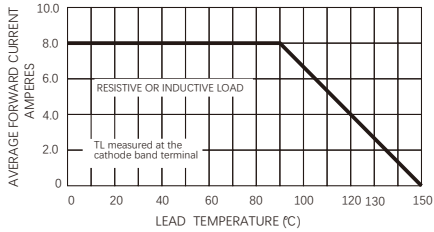

Fig.2-maximum Non-repetitive Peak Forward Surge Current

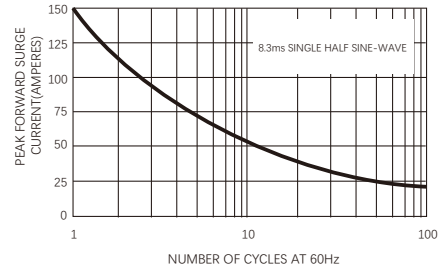

Fig.3-Typical Instantaneous Forward Characteristics

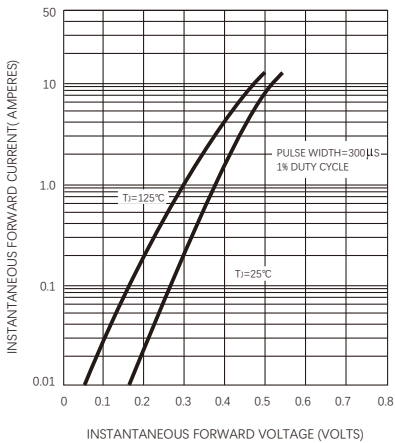

Fig.4-Typical Reverse Characteristics

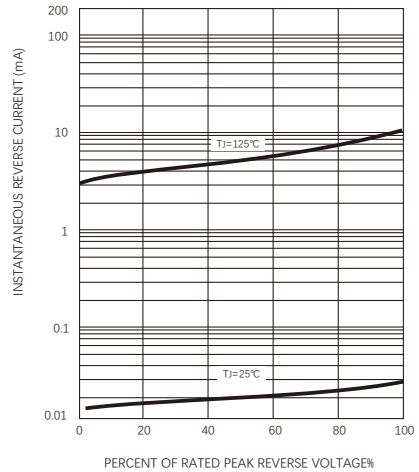
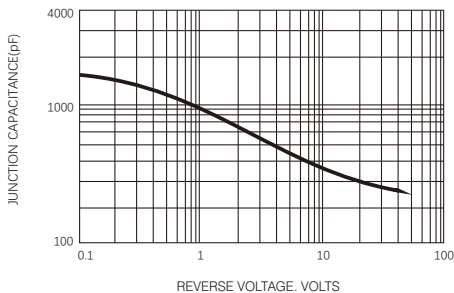

Fig.5-Typical Junction Capacitance



Friendship Reminder

- JiNan JingHeng(hereinafter referred to as JH) reserves the right to make changes to this document and its products and specifications at anytime without notice.
- Customers should obtain and confirm the latest product information and specifications before final design, purchase or use.
- JH makes no warranty, representation or guarantee regarding the suitability of its products for any particular purpose, nor does JH assume any liability for application assistance or customer product design.
- JH does not warrant or accept any liability with products which are purchased or used for any unintended or unauthorized application.
- No license is granted by implication or otherwise under any intellectual property rights of JH.
- JH's products are not authorized for use as critical components in life support devices or systems without express written approval of JH.